

# CASEWORK DESIGN SERIES (CDS)

(Page 15 of 20)

## 600 SERIES - LIBRARY CABINETS

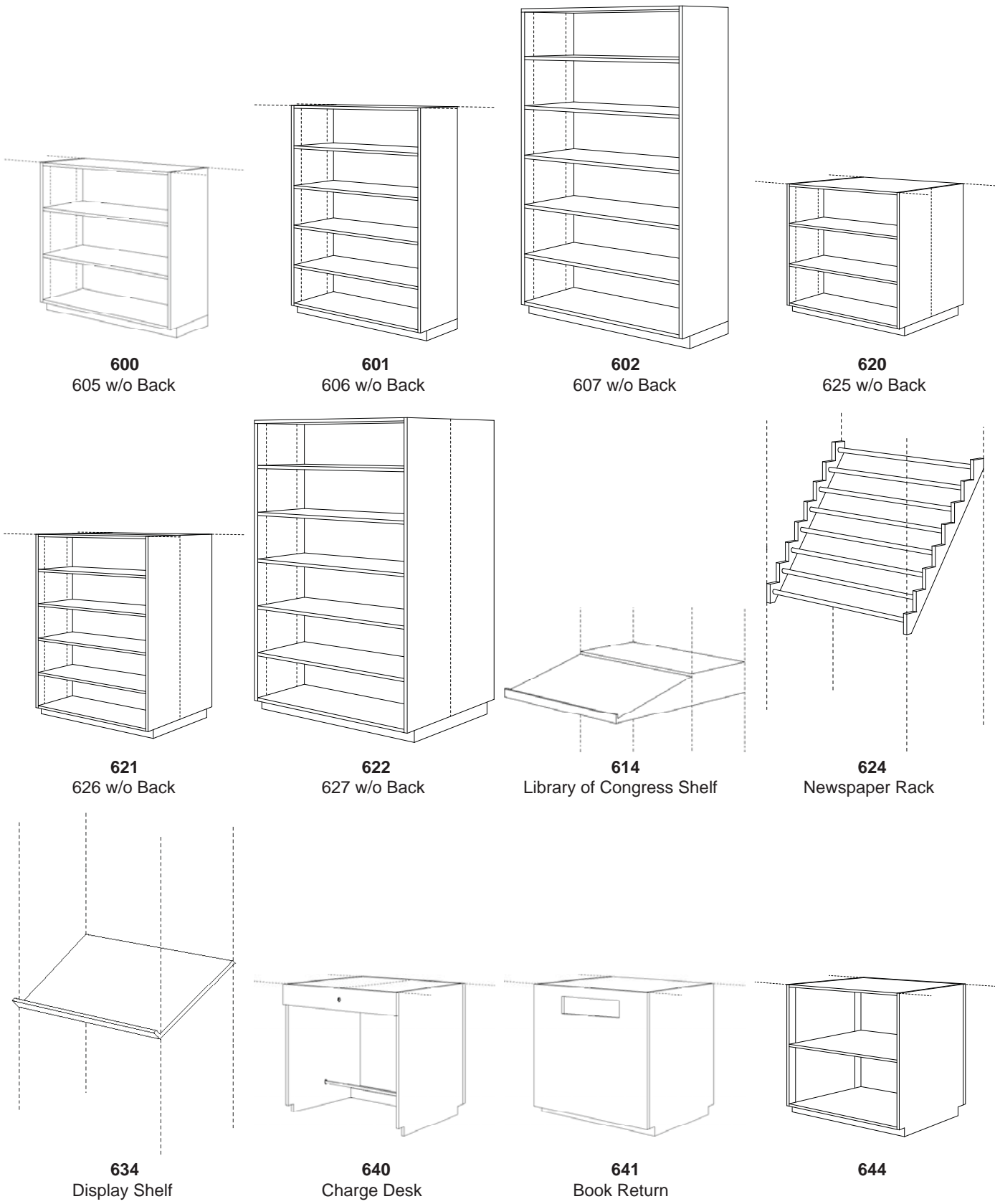

**A**

# CASEWORK DESIGN SERIES (CDS)

(Page 16 of 20)

## 600 SERIES - LIBRARY CABINETS

(continued)

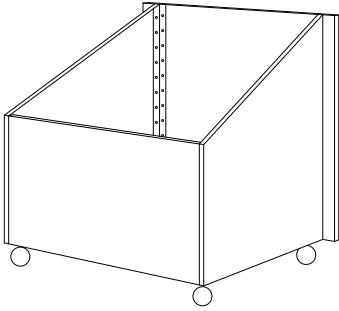

**651**  
Book Cart

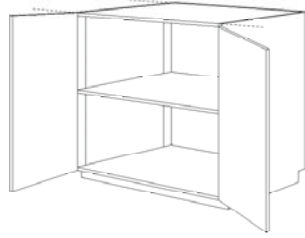

**654**

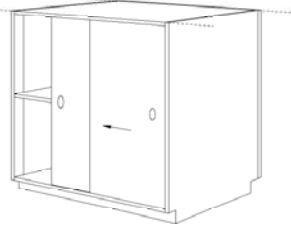

**664**

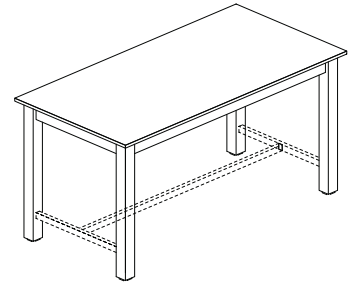

**671a**  
671b w/ Lateral Bracing

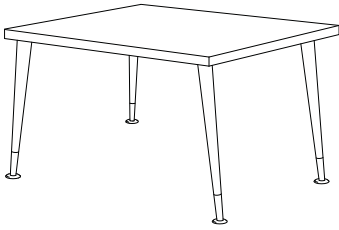

**672**

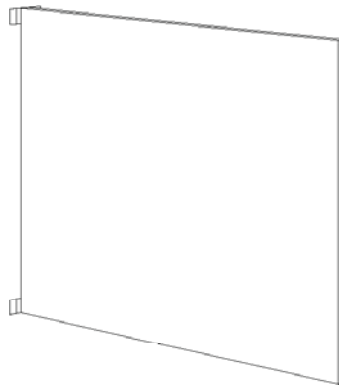

**673**  
Gate

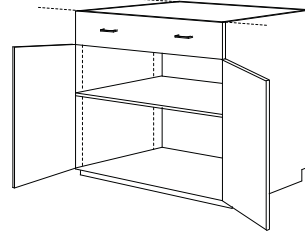

**674**

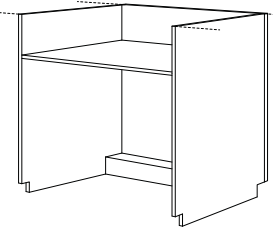

**681**

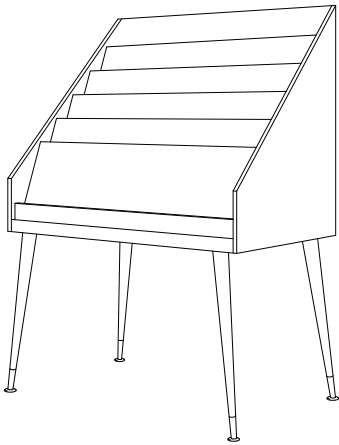

**682 / 692**  
Magazine Rack

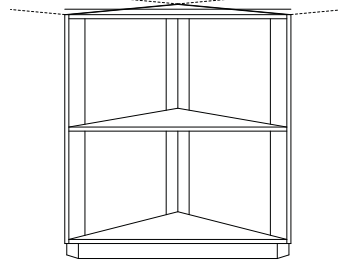

**683**

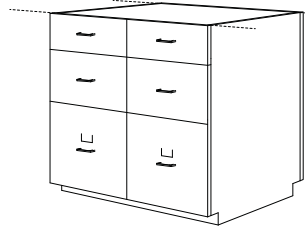

**684**

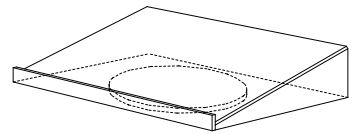

**693**  
Dictionary Stand